



ALLIOLiGHT Systemleuchten

TUBE

Beleuchtung in Maschinen für Industrie und Automation

- Chemikalienbeständiges Borosilikatglas
- Schutzklasse IP67
- Komplett wartungsfreies Produkt
- Hohe Energieeffizienz durch High Power LEDs
- Kompakte runde Bauform \varnothing 28 mm, für engste Einbausituationen geeignet
- Einfaches Nachrüsten in bestehenden Maschinen
- Mit drehbarer LED-Röhre
- Edelstahl Endkappen
- Kabelanschluss über M12 Steckerverbindung
- Netzspannung 24 V DC
- Befestigung mit Montageclips
- 50.000 h Lebensdauer
- Anschlussleitung optional erhältlich

Ausführung mit Borosilikatglas und 16,8 W

Art.-Nr. 81504

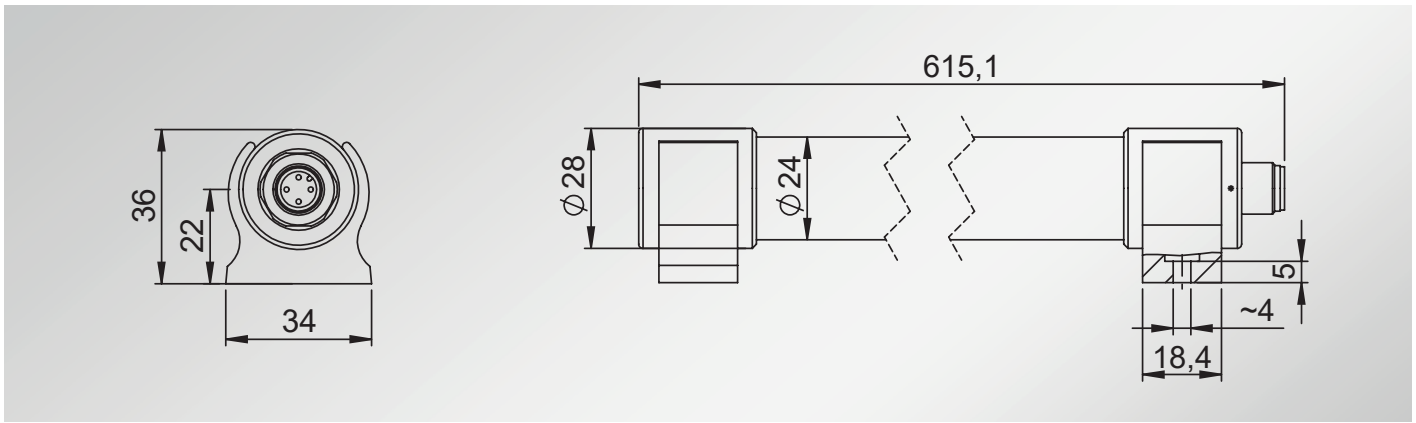

Montage

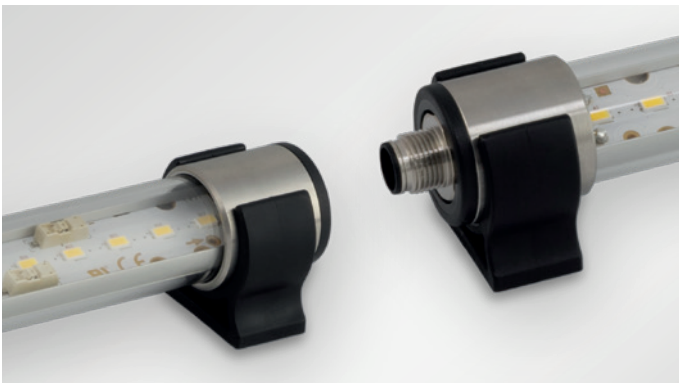

Befestigung mit Montageclips (im Lieferumfang enthalten)



Spezifikationen

TUBE	Art.-Nr. 81504
Elektrische Anschlusswerte	
Nennleistung	16,8 W
Nennspannung	24 V, DC $\pm 5\%$
Nennstrom	1,08 A
Anschlussleitung, optional	M12 Steckverbinder, 5 m/10 m, schwarz
Schutzart/Schutzklasse	
Schutzart	IP67
Schutzklasse	III (Schutzkleinspannung)
Leuchtmittel	High Power LED
Lichtstrom	2775 lm
Mittlere Lebensdauer	50.000 h
Lichtfarbe LED	5000 K
Farbwiedergabeindex CRI	>80

TUBE	Art.-Nr. 81504
Weitere Daten	
Kennzeichnung	CE, UKCA
Material Rohr	Borosilikatglas
Material Endkappen	Edelstahl
Material Montageclips	Polypropylen
Länge	615,1 mm
Durchmesser Rohr	24 mm
Durchmesser Endkappen	28 mm
Gewicht ohne Befestigung	ca. 400 g
Betriebstemperatur	-20 °C bis +50 °C
Luftfeuchtigkeit	5 – 95%



ALLIOLIGHT lighting systems

TUBE

Lighting in machinery for industry and automation

- Chemical-resistant borosilicate glass tube
- IP67 protection
- Completely maintenance-free product
- High energy efficiency thanks to High Power LED
- Compact round design \varnothing 28 mm, suitable for the tightest installation situations
- Easy retrofitting in existing machines
- With rotating LED tube
- Stainless steel end caps
- Cable connection via M12 connector
- Nominal voltage 24 V DC
- Assembly with mounting clips (included in the delivery)
- Service life 50 000 hours
- Connecting cable available as an option

Version with borosilicate glass tube and 16,8 W

Order No. 81504

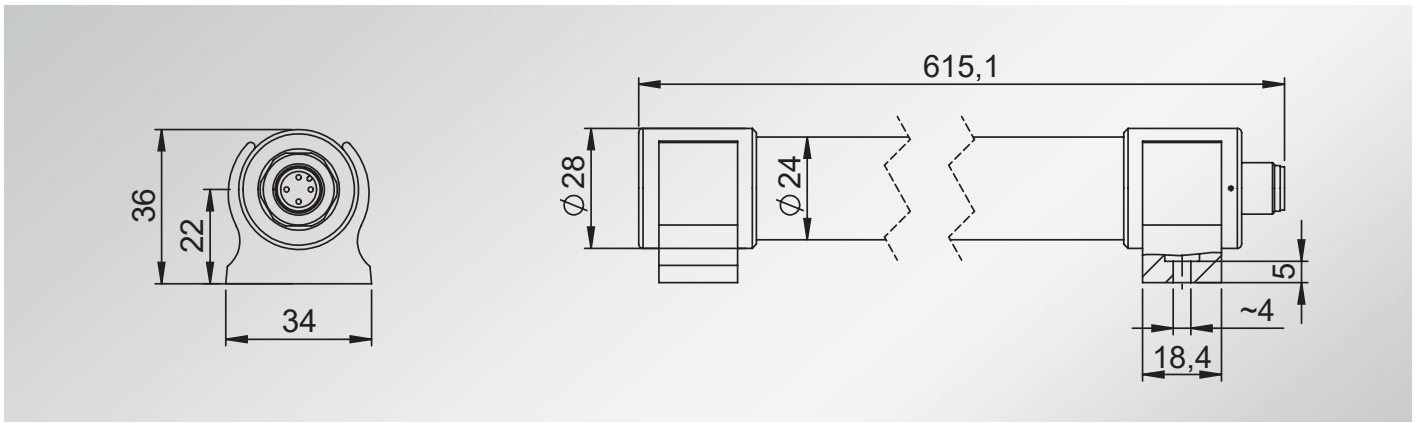

Assembly

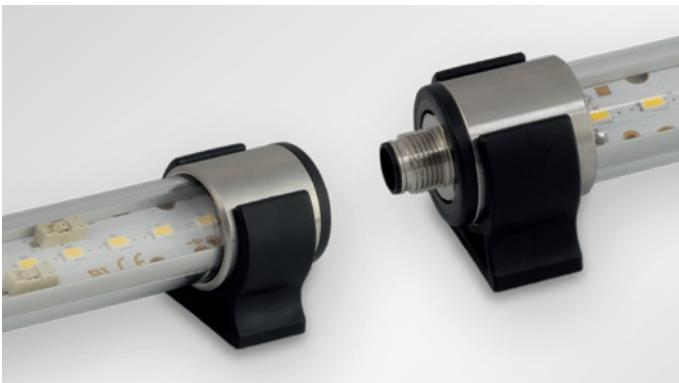

Assembly with mounting clips (included in the delivery)



Specifications

TUBE	81504
Technical data	
Rated power	16.8 W
Rated voltage	24 V, DC $\pm 5\%$
Rated current	1.08 A
Connecting cable, optional	M12 connector, 5 m/10 m, colour black
Protection class, category	
Protection class	IP67
Protection category	III (Protective extra-low voltage)
Luminant	High Power LED
Luminous flux	2775 lm
Light colour	5000 K
Colour rendering index CRI	> 80
Service life	50 000 h

TUBE	81504
Other specifications	
Labelling	CE, UKCA
Material tube	Boosilicate glass
Material end caps	Stainless steel
Material mounting clips	Polypropylen
Length	615.1 mm
Diameter tube	24 mm
Diameter end caps	28 mm
Weight without clips	ca. 400 g
Operating temperature	-20 °C to +50 °C
Humidity	5 – 95 %